



House Of Premium Brass Hardware

NOW
AVAILABLE IN
PVD



INDEX



House Of Premium Brass Hardware

HINGES

Butt Hinges, Cut Type Butt Hinges	01
Cut Type Railway Hinges	
Reflex Hinges, Railway Hinges,	02
Railway Cut Washer Hinges	
W Hinges, Parliament Hinges, W Type Hinges	03
Bearing Hinges with Doom/Flat top, Overlay Hinges	04
L Hinges, Lock L Hinges	05

TOWER BOLTS

Tower Bolt, Tower Ball Type	06
Conceal Round TB, Square TB,	07
Half Round TB, Triangle TB	
Flower TB, Stipple TB, Volvo TB, Jade TB	08
Wardrobe Bolt, Toyal TB, Cam Bolt,	09
Long Series TB, Premium Neck Bolt Heavy	

BOLT / LATCH

Premium Neck Bolt, Flush Tower Bolt,	10
Baty Latch, U Latch, Door Chain	

WINDOW FITTINGS

Window Adjuster, Regal Window Adjuster,	11
Telescopic Window Adjuster, Imported Window Aduster	

GATE HOOK / MIRROR CAP

Gate Hook, Fancy Gate Hook, Road Latch,	12
Tie Rod, Mirror Cap	

ALDROPS

Plus Aldrop, V Aldrop, Georgen Aldrop, Plus Tadi	13
--	----

ACCESSORIES

Door View, Door Stopper, Puss Pull,	14
Pyramid Bracket, D Bracket	
Square Bracket, Square Pivot, Square Folding,	15
Glass Pivot, Mirror Bracket	

FITTINGS

Fittings, Rope Fittings, Zula Accessories	16
---	----



HBL/HBM



HCL



RCL

Butt Hinges

CODE	SIZE IN MM	SIZE IN INCH
Butt Dia. 6(1/4) Thickness 2 (3/32)		
HBL 312	75 x 12	3 x 1/2
HBL 316	75 x 16	3 x 5/8
HBL 319	75 x 19	3 x 3/4
HBL 419	100 x 19	4 x 3/4
HBL 322	75 x 22	3 x 7/8
HBL 422	100 x 22	4 x 7/8
HBL 325	75 x 25	3 x 1
HBL 425	100 x 25	4 x 1
Butt Dia. 8(5/16) Thickness 3 (1/8)		
HBM 319	75 x 19	3 x 3/4
HBM 419	100 x 19	4 x 3/4
HBM 322	75 x 22	3 x 7/8
HBM 422	100 x 22	4 x 7/8
HBM 325	75 x 25	3 x 1
HBM 425	100 x 25	4 x 1

Cut Type Butt Hinges

CODE	SIZE IN MM	SIZE IN INCH
Butt Dia. 6(1/4) Thickness 2 (3/32)		
HCL 0316	75 x 9 x 16	3 x 3/8 x 5/8
HCL 0416	100 x 9 x 16	4 x 3/8 x 5/8
HCL 0319	75 x 9 x 19	3 x 3/8 x 3/4
HCL 0419	100 x 9 x 19	4 x 3/8 x 3/4
HCL 0325	75 x 9 x 25	3 x 3/8 x 1
HCL 0425	100 x 9 x 25	4 x 3/8 x 1
HCL 1319	75 x 12 x 19	3 x 1/2 x 3/4
HCL 1419	100 x 12 x 19	4 x 1/2 x 3/4
HCL1325	75 x 12 x 25	3 x 1/2 x 1
HCL 1425	100 x 12 x 25	4 x 1/2 x 1
HCL 2325	75 x 19 x 25	3 x 3/4 x 1
HCL 2425	100 x 19 x 25	4 x 3/4 x 1

Cut Type Railway Hinges

CODE	SIZE IN MM	SIZE IN INCH
Butt Dia. 6(1/4) Thickness 2 (3/32)		
RCL 1319	75 x 12 x 19	3 x 1/2 x 3/4
RCL 1419	100 x 12 x 19	4 x 1/2 x 3/4
RCL 1338	75 x 12 x 38	3 x 1/2 x 1.1/2
RCL 1438	100 x 12 x 38	4 x 1/2 x 1.1/2
RCL 2338	75 x 19 x 38	3 x 3/4 x 1.1/2
RCL 2438	100 x 19 x 38	4 x 3/4 x 1.1/2



HR 1113/1114



HR/EHR



CWHR

Reflex Hinges

CODE	SIZE IN MM	SIZE IN INCH
HR 1113	75	3
HR 1114	100	4

Railway Hinges

CODE	SIZE IN MM	SIZE IN INCH
Butt Dia.6(1/4) Thickness 2(3/32)		
HR 6319	75 x 19	3 x 3/4
HR 6419	100 x 19	4 x 3/4
HR 6322	75 x 22	3 x 7/8
HR 6422	100 x 22	4 x 7/8
Butt Dia.8(5/16) Thickness 3(1/8)		
HR 8322	75 x 22	3 x 7/8
HR 8422	100 x 22	4 x 7/8
Butt Dia.9(3/8) Thickness 3(1/8)		
HR 9325	75 x 25	3 x 1
HR 9425	100 x 25	4 x 1
HR 9525	125 x 25	5 x 1
HR 9625	150 x 25	6 x 1
Butt Dia.10(13/32) Thickness 3.5(9/64)		
HR 1428	100 x 28	4 x 1.1/8
HR 1528	125 x 28	5 x 1.1/8
HR 1628	150 x 28	6 x 1.1/8
Butt Dia.10(13/32) Thickness 4(5/32)		
HR 431	100 x 31	4 x 1.1/4
HR 531	125 x 31	5 x 1.1/4
HR 631	150 x 31	6 x 1.1/4
Butt Dia.12(15/32) Thickness 4.5(3/16)		
EHR 428	100 x 28	4 x 1.1/8
EHR 528	125 x 28	5 x 1.1/8
EHR 628	150 x 28	6 x 1.1/8
EHR 431	100 x 31	4 x 1.1/4
EHR 531	125 x 31	5 x 1.1/4
EHR 631	150 x 31	6 x 1.1/4
EHR 438	100 x 38	4 x 1.1/2
EHR 538	125 x 38	5 x 1.1/2
EHR 638	150 x 38	6 x 1.1/2
EHR 838	200 x 38	8 x 1.1/2

Railway Cut Washer Hinges

CODE	SIZE IN MM	SIZE IN INCH
(Without SL) Butt Dia.10(13/32) Thickness 3.5 (9/64)		
CWHR 428	100 x 28	4 x 1.1/8
CWHR 528	125 x 28	5 x 1.1/8
CWHR 628	150 x 28	6 x 1.1/8
CWHR 431	100 x 31	4 x 1.1/4
CWHR 531	125 x 31	5 x 1.1/4
CWHR 631	150 x 31	6 x 1.1/4
CWHR 438	100 x 38	4 x 1.1/2
CWHR 538	125 x 38	5 x 1.1/2
CWHR 638	150 x 38	6 x 1.1/2



Parliament Hinges

CODE	SIZE IN MM	SIZE IN INCH
PH 7550	75 x 50	3 x 2
PH 7575	75 x 75	3 x 3
PH 10050	100 x 50	4 x 2
PH 10075	100 x 75	4 x 3
PH 100100	100 x 100	4 x 4
PH 100125	100 x 125	4 x 5
PH 100150	100 x 150	4 x 6
PH 100200	100 x 200	4 x 8
PH 125100	125 x 100	5 x 4
PH 125125	125 x 125	5 x 5
PH 125150	125 x 150	5 x 6
PH 125200	125 x 200	5 x 8

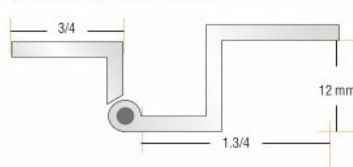


W Hinges

CODE	SIZE IN MM	SIZE IN INCH
WH 050	50	2
WH 075	75	3
WH 100	100	4

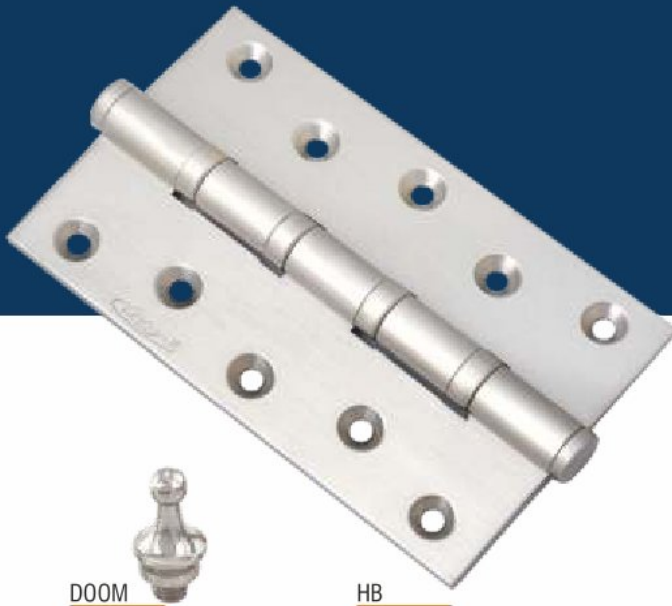


Exhibit: 4 x 3/4 x 1.3/4 - 12 mm



W Type Hinges

CODE	SIZE IN MM	SIZE IN INCH
WTH 33812	75 x 12 x 38 x 12	3 x 1/2 x 1.1/2
WTH 43812	100 x 12 x 38 x 12	4 x 1/2 x 1.1/2
WTH 33819	75 x 12 x 38 x 19	3 x 1/2 x 1.1/2
WTH 43819	100 x 12 x 38 x 19	4 x 1/2 x 1.1/2
WTH 33825	75 x 12 x 38 x 25	3 x 1/2 x 1.1/2
WTH 43825	100 x 12 x 38 x 25	4 x 1/2 x 1.1/2
WTH 34512	75 x 19 x 45 x 12	3 x 3/4 x 1.3/4
WTH 44512	100 x 19 x 45 x 12	4 x 3/4 x 1.3/4
WTH 34519	75 x 19 x 45 x 19	3 x 3/4 x 1.3/4
WTH 44519	100 x 19 x 45 x 19	4 x 3/4 x 1.3/4
WTH 34525	75 x 19 x 45 x 25	3 x 3/4 x 1.3/4
WTH 44525	100 x 19 x 45 x 25	4 x 3/4 x 1.3/4



DOOM

HB

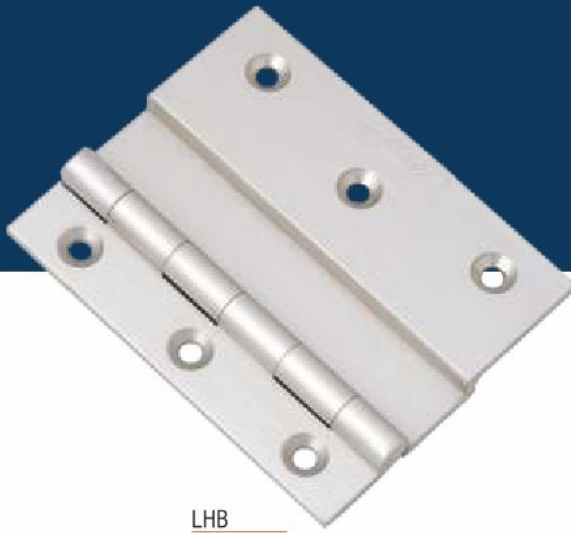
Bearing Hinges With Doornail / Flat Top

CODE	SIZE IN MM	SIZE IN INCH
(4 Bearing) Butt Dia. 12(15/32), Thickness 3(1/8)		
HB 3363	075 x 63	3 x 2.1/2
HB 3475	100 x 75	4 x 3
HB 3575	125 x 75	5 x 3
HB 3675	150 x 75	6 x 3
(4 Bearing) Butt Dia. 12(15/32), Thickness 4(5/32)		
HB 4428	100 x 28	4 x 1.1/8
HB 4528	125 x 28	5 x 1.1/8
HB 4628	150 x 28	6 x 1.1/8
HB 4475	100 x 75	4 x 3
HB 4575	125 x 75	5 x 3
HB 4675	150 x 75	6 x 3
HB 4588	125 x 88	5 x 3.1/2
HB 4688	150 x 88	6 x 3.1/2
HB 4888	200 x 88	8 x 3.1/2
HB 4400	100 x 100	4 x 4
HB 4500	125 x 100	5 x 4
HB 4600	150 x 100	6 x 4
(4 Bearing) Butt Dia. 16(5/8), Thickness 5(13/64)		
HB 5575	125 x 75	5 x 3
HB 5675	150 x 75	6 x 3
HB 5875	200 x 75	8 x 3
HB 5588	125 x 88	5 x 3.1/2
HB 5688	150 x 88	6 x 3.1/2
HB 5888	200 x 88	8 x 3.1/2
HB 55100	125 x 100	5 x 4
HB 56100	150 x 100	6 x 4
HB 58100	200 x 100	8 x 4
HB 510100	250 x 100	10 x 4
HB 512100	300 x 100	12 x 4



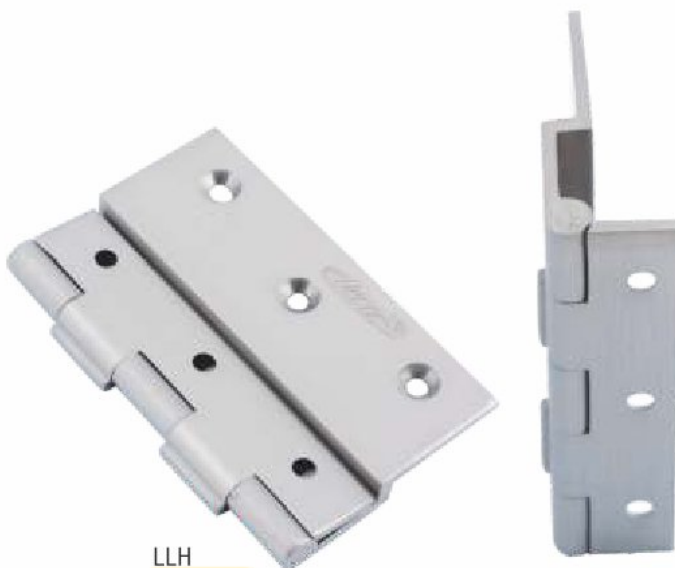
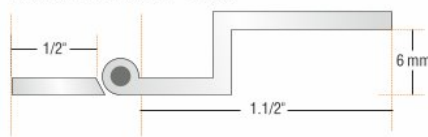
Overlay 'L' Hinges

CODE	SIZE IN MM	SIZE IN INCH
OVDF 21919	50 x 19 x 19	2 x 3/4 x 3/4
OVDF 31919	75 x 19 x 19	3 x 3/4 x 3/4
OVDF 41919	100 x 19 x 19	4 x 3/4 x 3/4
OVDF 31925	75 x 19 x 25	3 x 3/4 x 1
OVDF 41925	100 x 19 x 25	4 x 3/4 x 1
OVDF 32525	75 x 25 x 25	3 x 1 x 1
OVDF 42525	100 x 25 x 25	4 x 1 x 1
OVDF 32519	75 x 25 x 19	3 x 1 x 3/4
OVDF 42519	100 x 25 x 19	4 x 1 x 3/4
OVDF 33525	75 x 35 x 25	3 x 1.1/2 x 1
OVDF 33525	100 x 35 x 25	4 x 1.1/2 x 1



LHB

Exhibit : 3 x 1/2 x 1.1/2 - 6 mm



LLH

'L' Hinges

CODE	SIZE IN MM	SIZE IN INCH
LHB 1331	75 x 9 x 31 x 6	3 x 3/8 x 1.1/4
LHB 1431	100 x 9 x 31 x 6	4 x 3/8 x 1.1/4
LHB 1338	75 x 12 x 38 x 6	3 x 1/2 x 1.1/2
LHB 1438	100 x 12 x 38 x 6	4 x 1/2 x 1.1/2
LHB 2338	75 x 19 x 45 x 6	3 x 3/4 x 1.3/4
LHB 2438	100 x 19 x 45 x 6	4 x 3/4 x 1.3/4
LHB3126	75 x 25 x 50 x 6	3 x 1 x 2
LHB 4126	100 x 25 x 50 x 6	4 x 1 x 2
LHB 33112	75 x 9 x 31 x 12	3 x 3/8 x 1.1/4
LHB 43112	100 x 9 x 31 x 12	4 x 3/8 x 1.1/4
LHB 33812	75 x 12 x 38 x 12	3 x 1/2 x 1.1/2
LHB 43812	100 x 12 x 38 x 12	4 x 1/2 x 1.1/2
LHB 34512	75 x 19 x 45 x 12	3 x 3/4 x 1.3/4
LHB 44512	100 x 19 x 45 x 12	4 x 3/4 x 1.3/4
LHB 33119	75 x 9 x 31 x 19	3 x 3/8 x 1.1/4
LHB 43119	100 x 9 x 31 x 19	4 x 3/8 x 1.1/4
LHB 33819	75 x 12 x 38 x 19	3 x 1/2 x 1.1/2
LHB 43819	100 x 12 x 38 x 19	4 x 1/2 x 1.1/2
LHB 34519	75 x 19 x 45 x 19	3 x 3/4 x 1.3/4
LHB 44519	100 x 19 x 45 x 19	4 x 3/4 x 1.3/4
LHB 31219	75 x 25 x 50 x 19	3 x 1 x 2
LHB 41219	100 x 25 x 50 x 19	4 x 1 x 2
LHB 33825	75 x 12 x 38 x 25	3 x 1/2 x 1.1/2
LHB 43825	100 x 12 x 38 x 25	4 x 1/2 x 1.1/2
LHB 34525	75 x 19 x 45 x 25	3 x 3/4 x 1.3/4
LHB 44525	100 x 19 x 45 x 25	4 x 3/4 x 1.3/4
LHB 31225	75 x 25 x 50 x 25	3 x 1 x 2
LHB 41225	100 x 25 x 50 x 25	4 x 1 x 2

Lock 'L' Hinges

CODE	SIZE IN MM	SIZE IN INCH
LLH 1331	75 x 9 x 31 x 6	3 x 3/8 x 1.1/4
LLH 1431	100 x 9 x 31 x 6	4 x 3/8 x 1.1/4
LLH 1338	75 x 12 x 38 x 6	3 x 1/2 x 1.1/2
LLH 1438	100 x 12 x 38 x 6	4 x 1/2 x 1.1/2
LLH 2338	75 x 19 x 45 x 6	3 x 3/4 x 1.3/4
LLH 2438	100 x 19 x 45 x 6	4 x 3/4 x 1.3/4
LLH 33112	75 x 9 x 31 x 12	3 x 3/8 x 1.1/4
LLH 43112	100 x 9 x 31 x 12	4 x 3/8 x 1.1/4
LLH 33812	75 x 12 x 38 x 12	3 x 1/2 x 1.1/2
LLH 43812	100 x 12 x 38 x 12	4 x 1/2 x 1.1/2
LLH 34512	75 x 19 x 45 x 12	3 x 3/4 x 1.3/4
LLH 44512	100 x 19 x 45 x 12	4 x 3/4 x 1.3/4
LLH 33119	75 x 9 x 31 x 19	3 x 3/8 x 1.1/4
LLH 43119	100 x 9 x 31 x 19	4 x 3/8 x 1.1/4
LLH 33819	75 x 12 x 38 x 19	3 x 1/2 x 1.1/2
LLH 43819	100 x 12 x 38 x 19	4 x 1/2 x 1.1/2
LLH 34519	75 x 19 x 45 x 19	3 x 3/4 x 1.3/4
LLH 44519	100 x 19 x 45 x 19	4 x 3/4 x 1.3/4
LLH 33825	75 x 12 x 38 x 25	3 x 1/2 x 1.1/2
LLH 43825	100 x 12 x 38 x 25	4 x 1/2 x 1.1/2
LLH 34525	75 x 19 x 45 x 25	3 x 3/4 x 1.3/4
LLH 44525	100 x 19 x 45 x 25	4 x 3/4 x 1.3/4



TRL



TRM



TRM / TRHF

Tower Bolt

CODE	SIZE IN MM	SIZE IN INCH
Plate Thickness 1		
TRL 6050	6 x 50	1/4 x 2"
TRL 6063	6 x 63	1/4 x 2.1/2"
TRL 6075	6 x 75	1/4 x 3"
TRL 6100	6 x 100	1/4 x 4"
TRL 8075	8 x 75	5/16 x 3"
TRL 8100	8 x 100	5/16 x 4"
TRL 8150	8 x 150	5/16 x 6"
TRL 8200	8 x 200	5/16 x 8"
Plate Thickness 1.5		
TRM 9075	9 x 75	3/8 x 3"
TRM 9100	9 x 100	3/8 x 4"
TRM 9150	9 x 150	3/8 x 6"
TRM 9200	9 x 200	3/8 x 8"
TRM 9250	9 x 250	3/8 x 10"
TRM 9300	9 x 300	3/8 x 12"
TRM 9375	9 x 375	3/8 x 15"
TRM 9450	9 x 450	3/8 x 18"
TRM 9600	9 x 600	3/8 x 24"
TRM 12100	12 x 100	1/2 x 4"
TRM 12150	12 x 150	1/2 x 6"
TRM 12200	12 x 200	1/2 x 8"
TRM 12250	12 x 250	1/2 x 10"
TRM 12300	12 x 300	1/2 x 12"
TRM 12375	12 x 375	1/2 x 15"
TRM 12450	12 x 450	1/2 x 18"
TRM 12600	12 x 600	1/2 x 24"
TRM 12750	12 x 750	1/2 x 30"
TRM 12900	12 x 900	1/2 x 36"

Tower Bolt Ball Type

CODE	SIZE IN MM	SIZE IN INCH
Plate Thickness 1.5 MM (1/16)		
TRM 95075	9.5 x 75	3/8 x 3"
TRM 95100	9.5 x 100	3/8 x 4"
TRM 95150	9.5 x 150	3/8 x 6"
TRM 95200	9.5 x 200	3/8 x 8"
TRM 95250	9.5 x 250	3/8 x 10"
TRM 95300	9.5 x 300	3/8 x 12"
TRM 95375	9.5 x 375	3/8 x 15"
TRM 95450	9.5 x 450	3/8 x 18"
TRM 95600	9.5 x 600	3/8 x 24"
Plate Thickness 2 MM		
TRHF 10075	10 X 75	25/64 X 3"
TRHF 10100	10 X 100	25/64 X 4"
TRHF 10150	10 X 150	25/64 X 6"
TRHF 10200	10 X 200	25/64 X 8"
TRHF 10250	10 X 250	25/64 X 10"
TRHF 10300	10 X 300	25/64 X 12"
TRHF 10375	10 X 375	25/64 X 15"
TRHF 10450	10 X 450	25/64 X 18"
TRHF 10600	10 X 600	25/64 X 24"



TRH



CRTB



STB



HRTB / HHRTB

Tower Bolt

CODE	SIZE IN MM	SIZE IN INCH
Plate Thickness 2.5 MM		
TRH 10075	10 X 75	25/64 X 3"
TRH 10100	10 X 100	25/64 X 4"
TRH 10150	10 X 150	25/64 X 6"
TRH 10200	10 X 200	25/64 X 8"
TRH 10250	10 X 250	25/64 X 10"
TRH 10300	10 X 300	25/64 X 12"
TRH 10375	10 X 375	25/64 X 15"
TRH 10450	10 X 450	25/64 X 18"
TRH 10600	10 X 600	25/64 X 24"

Conceal Round Tower Bolt

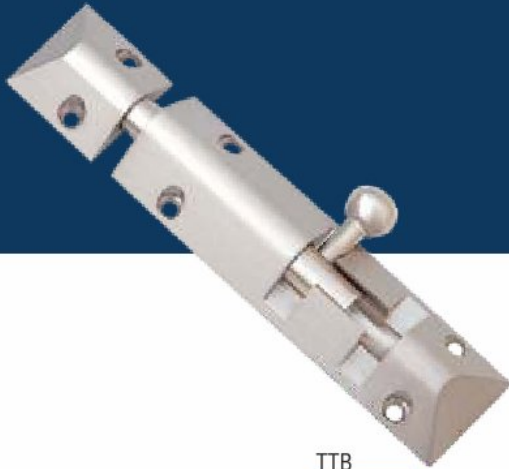
CODE	SIZE IN MM	SIZE IN INCH
CRTB 075	75	3"
CRTB 100	100	4"
CRTB 150	150	6"
CRTB 200	200	8"
CRTB 250	250	10"
CRTB 300	300	12"
CRTB 375	375	15"
CRTB 450	450	18"
CRTB 600	600	24"

Square Tower Bolt

CODE	SIZE IN MM	SIZE IN INCH
STB 100	100	4"
STB 150	150	6"
STB 200	200	8"
STB 250	250	10"
STB 300	300	12"
STB 375	375	15"
STB 450	450	18"
STB 600	600	24"

Half Round Tower Bolt

CODE	SIZE IN MM	SIZE IN INCH
LIGHT		
HRTB 075	75	3"
HRTB 100	100	4"
HRTB 150	150	6"
HRTB 200	200	8"
HRTB 250	250	10"
HRTB 300	300	12"
HRTB 375	375	15"
HRTB 450	450	18"
HRTB 600	600	24"
HEAVY		
HHRTB 100	100	4"
HHRTB 150	150	6"
HHRTB 200	200	8"
HHRTB 250	250	10"
HHRTB 300	300	12"
HHRTB 375	375	15"
HHRTB 450	450	18"
HHRTB 600	600	24"



TTB



FTB / HFTB



STP



VTB

Triangle Tower Bolt

CODE	SIZE IN MM	SIZE IN INCH
TTB 100	100	4"
TTB 150	150	6"
TTB 200	200	8"
TTB 250	250	10"
TTB 300	300	12"

Flower Tower Bolt

CODE	SIZE IN MM	SIZE IN INCH
LIGHT		
FTB 075	75	3"
FTB 100	100	4"
FTB 150	150	6"
FTB 200	200	8"
FTB 250	250	10"
FTB 300	300	12"
FTB 375	375	15"
FTB 450	450	18"
HEAVY		
HFTB 100	100	4"
HFTB 150	150	6"
HFTB 200	200	8"
HFTB 250	250	10"
HFTB 300	300	12"
HFTB 375	375	15"
HFTB 450	450	18"

Staple Bolt

CODE	SIZE IN MM	SIZE IN INCH
STP 100	100	4"
STP 150	150	6"
STP 200	200	8"

Volvo Tower Bolt

CODE	SIZE IN MM	SIZE IN INCH
MEDIUM		
VTB 100	100	4"
VTB 150	150	6"
VTB 200	200	8"
VTB 250	250	10"
VTB 300	300	12"
HEAVY		
HVTB 100	100	4"
HVTB 150	150	6"
HVTB 200	200	8"
HVTB 250	250	10"
HVTB 300	300	12"
HVTB 375	375	15"
HVTB 450	450	18"



WARDROBE BOLT
(Central Lock)

Long Series Heavy Tower Bolts

CODE	SIZE IN MM	SIZE IN INCH
(16 MM)		
TRM 16150	16 x 150	5/8 X 6"
TRM 16200	16 x 200	5/8 X 8"
TRM 16250	16 x 250	5/8 X 10"
TRM 16300	16 x 300	5/8 X 12"
TRM 16375	16 x 375	5/8 X 15"
TRM 16450	16 x 450	5/8 X 18"
TRM 16600	16 x 600	5/8 X 24"
TRM 16750	16 x 750	5/8 X 30"
TRM 16900	16 x 900	5/8 X 36"
(19 MM)		
TRM 19450	19 x 450	3/4 X 18"
TRM 19600	19 x 600	3/4 X 24"
TRM 19750	19 x 750	3/4 X 30"
TRM 19900	19 x 900	3/4 X 36"
TRM 191200	19 x 1200	3/4 X 48"
TRM 191500	19 x 1500	3/4 X 60"

Royal Tower Bolt

CODE	SIZE IN MM	SIZE IN INCH
RHTB 100	100	4"
RHTB 150	150	6"
RHTB 200	200	8"
RHTB 250	250	10"
RHTB 300	300	12"
RHTB 375	375	15"
RHTB 450	450	18"
RHTB 600	600	24"

Premium Neck Bolt Heavy

CODE	SIZE IN MM	SIZE IN INCH
PNBH 11100	100 x 11	4"
PNBH 11150	150 x 11	6"
PNBH 11200	200 x 11	8"
PNBH 11250	250 x 11	10"
PNBH 11300	300 x 11	12"
PNBH 11375	375 x 11	15"
PNBH 11450	450 x 11	18"
PNBH 11600	600 x 11	24"
PNBH 11900	900 x 11	36"



CAM BOLT

Premium Neck Bolt

CODE	SIZE IN MM	SIZE IN INCH
PNB 9075	075 x 8.5	3"
PNB 9100	100 x 8.5	4"
PNB 9150	150 x 8.5	6"
PNB 9200	200 x 8.5	8"
PNB 9250	250 x 8.5	10"
PNB 9300	300 x 8.5	12"
PNB 9375	375 x 8.5	15"
PNB 9450	450 x 8.5	18"
PNB 9600	600 x 8.5	24"

Flush Tower Bolt

CODE	SIZE IN MM	SIZE IN INCH
Flush Tower Bolt		
FH 19100	19 x 100	3/4 x 4"
FH 19150	19 x 150	3/4 x 6"
FH 19200	19 x 200	3/4 x 8"
FH 19250	19 x 250	3/4 x 10"
FH 19300	19 x 300	3/4 x 12"
FH 19375	19 x 375	3/4 x 15"
FH 19450	19 x 450	3/4 x 18"
FH 19600	19 x 600	3/4 x 24"
FH 19750	19 x 750	3/4 x 30"
FH 19900	19 x 900	3/4 x 36"
FH 25150	25 x 150	1 x 6"
FH 25200	25 x 200	1 x 8"
FH 25250	25 x 250	1 x 10"
FH 25300	25 x 300	1 x 12"
FH 25375	25 x 375	1 x 15"
FH 25450	25 x 450	1 x 18"
FH 25600	25 x 600	1 x 24"
FH 25750	25 x 750	1 x 30"
FH 25900	25 x 900	1 x 36"
FH 251200	25 x 1200	1 x 48"

Baby Latch

CODE	SIZE IN MM	SIZE IN INCH
Square Heavy		
BLH 050	50	2"
BLH 075	75	3"
BLH 100	100	4"
TBL 075	75	3"
TBL 100	100	4"

'U' Latch

CODE	SIZE IN MM	SIZE IN INCH
UBL 100	100	4"
UBL 150	150	6"
UBL 200	200	8"
UBL 250	250	10"
UBL 300	300	12"
UBL 450	450	18"
UBL 600	600	24"



PNB



FH



BLH



TBL



UBL



DRC

Door Chain

CODE	SIZE IN MM	SIZE IN INCH
DRC		

Window Adjuster

CODE	SIZE IN MM	SIZE IN INCH
WA 200	200	8"
WA 250	250	10"
WA 300	300	12"
Deluxe		
DWA 150	150	6"

Regal Window Adjuster

CODE	SIZE IN MM	SIZE IN INCH
RWA 200	200	8"
RWA 250	250	10"
RWA 300	300	12"
Deluxe		
RDWA 150	150	6"

Telescopic Window Adjuster

CODE	SIZE IN MM	SIZE IN INCH
TWA 150	150	6 -12"
PREMIUM		
PAWL	200	8"

Imported Window Adjuster

CODE	SIZE IN MM	SIZE IN INCH
IWA	200	8"



DWA



RDWA



WA



TWA



PAWL



RWA



IWA



Gate Hook

CODE	SIZE IN MM	SIZE IN INCH
GH 050	50	2"
GH 063	63	2.1/2"
GH 075	75	3"
GH 100	100	4"
GH 125	125	5"
GH 150	150	6"
GH 200	200	8"

Fancy Gate Hook

CODE	SIZE IN MM	SIZE IN INCH
FGH 125	125	5"
FGH 150	150	6"
FGH 200	200	8"

Rod Latch

CODE	SIZE IN MM	SIZE IN INCH
RL 150	150	6"
RL 200	200	8"
RL 250	250	10"
RL 300	300	12"

Mirror Cap (Royal Star)



CODE	SIZE IN MM	SIZE IN INCH
MCRS 19	19	3/4"
MCRS 25	25	1"
MCRS 31	31	1.1/4"
MCRS 38	38	1.1/2"
MCRS 50	50	2"



Mirror Cap (Pyramid)

CODE	SIZE IN MM	SIZE IN INCH
MCP 12	12	1/2"
MCP 19	19	3/4"
MCP 25	25	1"
MCP 31	31	1.1/4"
MCP 38	38	1.1/2"
MCP 50	50	2"

Mirror Cap (Square)



CODE	SIZE IN MM	SIZE IN INCH
MCS 12	12	1/2"
MCS 19	19	3/4"
MCS 25	25	1"
MCS 31	31	1.1/4"
MCS 38	38	1.1/2"
MCS 50	50	2"



Mirror Cap (Round)

CODE	SIZE IN MM	SIZE IN INCH
MCR 12	12	1/2"
MCR 19	19	3/4"
MCR 25	25	1"
MCR 31	31	1.1/4"
MCR 38	38	1.1/2"
MCR 50	50	2"
MCR 63	63	2.1/2"
MCR 75	75	3"

Mirror Cap (Royal Pyramid)



CODE	SIZE IN MM	SIZE IN INCH
MCRP 31	31	1.1/4"
MCRP 38	38	1.1/2"
MCRP 50	50	2"



Mirror Cap (Doom)

CODE	SIZE IN MM	SIZE IN INCH
MCD 19	19	3/4"
MCD 25	25	1"
MCD 38	38	1.1/2"
MCD 50	50	2"

Plus Aldrop

CODE	SIZE IN MM	SIZE IN INCH
PAD 16200	16 x 200	5/8 x 8"
PAD 16250	16 x 250	5/8 x 10"
PAD 16300	16 x 300	5/8 x 12"
PAD 16350	16 x 350	5/8 x 14"



'V' Aldrop

CODE	SIZE IN MM	SIZE IN INCH
VAD 16200	16 x 200	5/8 x 8"
VAD 16250	16 x 250	5/8 x 10"
VAD 16300	16 x 300	5/8 x 12"
VAD 16350	16 x 350	5/8 x 14"
VAD 19300	19 x 300	3/4 x 12"
VAD 19350	19 x 350	3/4 x 14"
VAD 19400	19 x 400	3/4 x 16"
VAD 19450	19 x 450	3/4 x 18"



Georgen Aldrop

CODE	SIZE IN MM	SIZE IN INCH
GAD 16200	16 x 200	5/8 x 8"
GAD 16250	16 x 250	5/8 x 10"
GAD 16300	16 x 300	5/8 x 12"
GAD 16350	16 x 350	5/8 x 14"
GAD 19300	19 x 300	3/4 x 12"
GAD 19350	19 x 350	3/4 x 14"
GAD 19400	19 x 400	3/4 x 16"
GAD 19450	19 x 450	3/4 x 18"



Plus Tadi

CODE	SIZE IN MM	SIZE IN INCH
PTD 12200	12 x 200	1/2 x 8"
PTD 12250	12 x 250	1/2 x 10"
PTD 12300	12 x 300	1/2 x 12"





RSDV / DV
RBDV

PDV

SDV

Door View

CODE	SIZE	Design
RSDV	Regular	Round Small
DV	Regular	Round Large
RBDV	Large 3"	Round Large
PDV	Regular	Pyramid
SDV	Regular	Square



DRS

FDS

GDS

Door Stopper

CODE	SIZE IN MM	SIZE IN INCH
Heavy		
DRS	100	4"
Georgen Door Stopper		
GDS	85	3.1/2"
Flora Door Stopper		
FDS	100	4"

Push - Pull

CODE	SIZE IN INCH
PP 35	Regular 1.1/2"



PP

PB

Pyramid Brackets

CODE	SIZE IN MM	SIZE IN INCH
PB 150	150	6"
PB 225	225	9"
PB 300	300	12"
PB 375	375	15"

'D' Bracket

CODE	SIZE IN MM	SIZE IN INCH
DB 1126	38 X 6	1.1/2" x 6MM
DB 1128	38 X 8	1.1/2" x 8MM
DB 11212	38 X 12	1.1/2" x 12MM
DB 26	50 X 6	2" x 6MM
DB 28	50 X 8	2" x 8MM
DB 210	50 X 10	2" x 10MM
DB 212	50 X 12	2" x 12MM
DB 215	50 X 15	2" x 15MM

DB



SF



SF



SB



SP



GP



MB

Square Folding

CODE	SIZE IN MM	SIZE IN INCH
SF 18	25 x 8	1" x 8MM
SF 28	50 x 8	2" x 8MM
SF 112	25 x 12	1" x 12MM
SF 212	50 x 12	2" x 12MM
SF 383812	38 x 38 x 12	1.1/2"x1.1/2"x12MM
SF 753812	75 x 38 x 12	3" x 1.1/2" x 12MM
SF 753815	75 x 38 x 15	3" x 1.1/2" x 15MM
SF 753819	75 x 38 x 19	3" x 1.1/2" x 19MM
SF 1003812	100 x 38 x 12	4" x 1.1/2" x 12MM
SF 1003815	100 x 38 x 15	4" x 1.1/2" x 15MM
SF 1003819	100 x 38 x 19	4" x 1.1/2" x 19MM
SF 505012	50 x 50 x 12	2" x 2" x 12MM
SF 505015	50 x 50 x 15	2" x 2" x 15MM
SF 505019	50 x 50 x 19	2" x 2" x 19MM
SF 755012	75 x 50 x 12	3" x 2" x 12MM
SF 755015	75 x 50 x 15	3" x 2" x 15MM
SF 755019	75 x 50 x 19	3" x 2" x 19MM
SF 1005012	100 x 50 x 12	4" x 2" x 12MM
SF 1005015	100 x 50 x 15	4" x 2" x 15MM
SF 1005019	100 x 50 x 19	4" x 2" x 19MM

Square Bracket

CODE	SIZE IN MM	SIZE IN INCH
SB 18	25 x 8	1" x 8MM
SB 28	50 x 8	2" x 8MM
SB 112	25 x 12	1" x 12MM
SB 212	50 x 12	2" x 12MM
SB 312	75 x 12	3" x 12MM

Square Pivot

CODE	SIZE IN MM	SIZE IN INCH
SP 1126	38 x 6	1.1/2" x 6MM
SP 1128	38 x 8	1.1/2" x 8MM
SP 11212	38 x 12	1.1/2" x 12MM
SP 26	50 x 6	2" x 6MM
SP 28	50 x 8	2" x 8MM
SP 212	50 x 12	2" x 12MM

Glass Pivot (Patti Pivot)

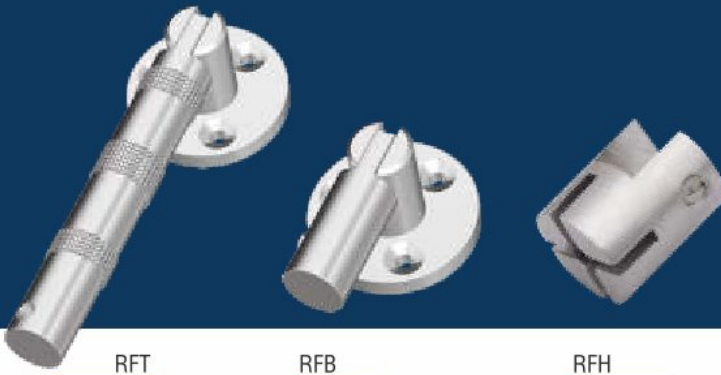
CODE	SIZE IN MM	SIZE IN INCH
GP 6338	63 x 38	2.1/2" X 1.1/2"
GP 10050	100 x 50	4" X 2"

Mirror Bracket

CODE	SIZE IN MM
MB 6	6MM
MB 8	8MM
MB 12	12MM

Imported Rope Fittings

CODE	SIZE IN MM
RFT	TOP
RFB	BOTTOM
RFH	HOLDER 12 MM



RFT

RFB

RFH

Fittings



Bearing Pivot



'L' Self Support



Bat



Oval Socket



Pipe Socket



Key Hole

ZULA ACCESSORIES



S Hook



Zula Hook



Zula Bearing Kada



Zula Bottom Kada



Plain Chain



Georgean Chain



Brass Screws (Phillip Head)

CODE	SIZE IN MM
SCR 154	15 X 4
SCR 204	20 X 4
SCR 206	20 X 6
SCR 309	30 X 9
SCR 4512	45 X 12